



CARBURETOR

P/N 0-80457S (electric choke)

P/N 0-1850S (manual choke)

INSTALLATION, TUNING, AND ADJUSTMENT MANUAL

199R11081

NOTE: These instructions must be read and fully understood before beginning installation. If this manual is not fully understood, installation should not be attempted. Failure to follow these instructions, including the pictures may result in subsequent system failure.

TABLE OF CONTENTS:

INTRODUCTION:	2
REMOVAL:	3
INSTALLATION:	3
ELECTRIC CHOKE MODELS:	5
MANUAL CHOKE MODELS:	5
INSTALLATION NOTES:	6
CHRYSLER APPLICATIONS:	6
FORD APPLICATIONS:	7
GM APPLICATIONS:	7
CONNECTING THE TRANSMISSION LINKAGE:	8
GM TH350, 200R4 /700R4	8
CHOKE ADJUSTMENT:	8
FUEL LEVEL:	9
IDLE MIXTURE NEEDLES:	10
VACUUM OPERATED SECONDARY THROTTLES:	11
VACUUM OPERATED SECONDARY TUNING:	11
JETTING (MAIN JETS):	13
POWER VALVES:	13
CARBURETOR SPECIFICATIONS:	13
HOLLEY STREET WARRIOR™ WARRANTY	14

INTRODUCTION:

CONGRATULATIONS on your Holley® carburetor purchase! We feel that you have purchased the finest performance carburetor manufactured today. Should you need information or parts assistance, please contact our Technical Service Department at 1-270-781-9741, Monday through Friday, 8 a.m. to 5 p.m. CST. Please have the part number of the product you purchased on hand when you call.

To preserve the warranty, these instructions must be read and followed thoroughly before and during installation.

ATTENTION! The information in this manual covers carburetor models 0-80457S and 0-1850S. For most pictures, the **0-80457S carburetor (equipped with electric choke) is shown in the illustrations in this manual.**

NOTE: The 0-80457S and 0-1850S carburetors are 50-state emission legal replacement carburetors for 1965-69 V-8 applications. In California, those vehicles **must** have been originally equipped with a four-barrel carburetor.

These carburetors have been designed and calibrated as a universal replacement carburetor for passenger cars and light truck applications equipped with V-6 and V-8 engines. It is designed for use on "square" flange intake manifolds. Carburetor adapters are not recommended to adapt to "spread" bore intake manifolds, since adapters may have an adverse effect on cylinder-to-cylinder distribution and ultimately, total engine performance. However, some manifolds may be universal (such as Weiand 8004). Please check with Holley's Technical Service Department if you have any questions.

REMOVAL:

1. Remove the air cleaner, exercising care to carefully detach any vacuum lines from the air cleaner and marking them so they can be reassembled to the air cleaner in the same manner.
2. Remove the existing carburetor by the following procedure:
 - A. Carefully disconnect the fuel line.

WARNING: Carefully protect the open end of the fuel lines, so that no foreign particles can enter. Wrap the end of the fuel line with a clean lint-free cloth.

- B. Disconnect and mark all vacuum lines and wiring (if any) to the carburetor.
 - C. Disconnect the PCV hose.
 - D. Disconnect the choke rod or heat tubes (if equipped).
 - E. Disconnect and remove the throttle linkage and automatic kickdown linkage. **Save all retaining clips.**
 - F. Unbolt and remove the carburetor from the manifold.
3. If the intake manifold is being changed at this time, install the new manifold according to the manifold's manufacturer's directions. Since we are not familiar with all manifold instructions, Holley® cannot accept responsibility for their validity.

INSTALLATION:

1. Install the carburetor-mounting studs (not provided) in the proper location on the intake manifold carburetor flange.
2. Place the new carburetor flange gasket, provided with the carburetor, in the proper position on the intake manifold.
3. Place the carburetor on top of the flange gasket on the manifold. Install the hold down nuts and snug down progressively in a "crisscross" pattern (60-80 in./lbs.), as shown in **Figure 1**.

WARNING: Overtightening may result in a warped or cracked carburetor throttle body.

4. Before connecting the linkage, operate the throttle lever to assure the correct travel (no sticking or binding), by opening to wide-open throttle and back to closed throttle several times. Correct any sticking or binding conditions before proceeding.

WARNING: Any sticking, binding, or other interference in the throttle linkage could result in uncontrolled engine speed. This could result in engine damage or personal injury.

5. Reconnect the throttle and transmission kickdown linkage and throttle return spring (Holley® P/N 20-89). Operate the carburetor throttle lever by hand to assure the correct travel (no sticking or binding) by opening to wide open throttle and back to closed throttle several times. Correct any sticking or binding conditions before proceeding.

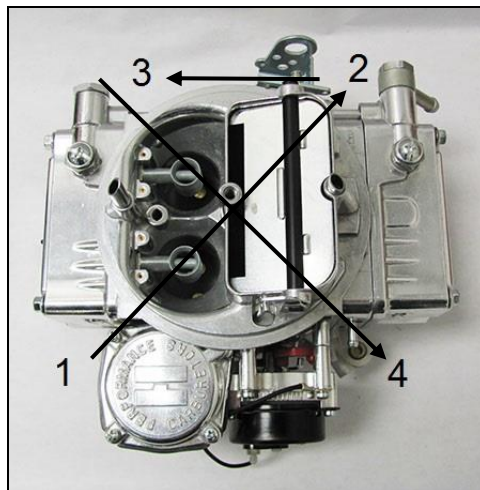

Figure 1—Carburetor torque sequence (all Holley® carburetors)

NOTE: With the engine turned off, have an assistant slowly press the accelerator pedal to the floor, while you watch the throttle for any sticking or binding. Correct any sticking or binding conditions before proceeding. Also ensure that you are reaching full throttle. Many performance problems are traced to partial throttle openings from improperly adjusted linkage. Secondaries will not open mechanically during this procedure.

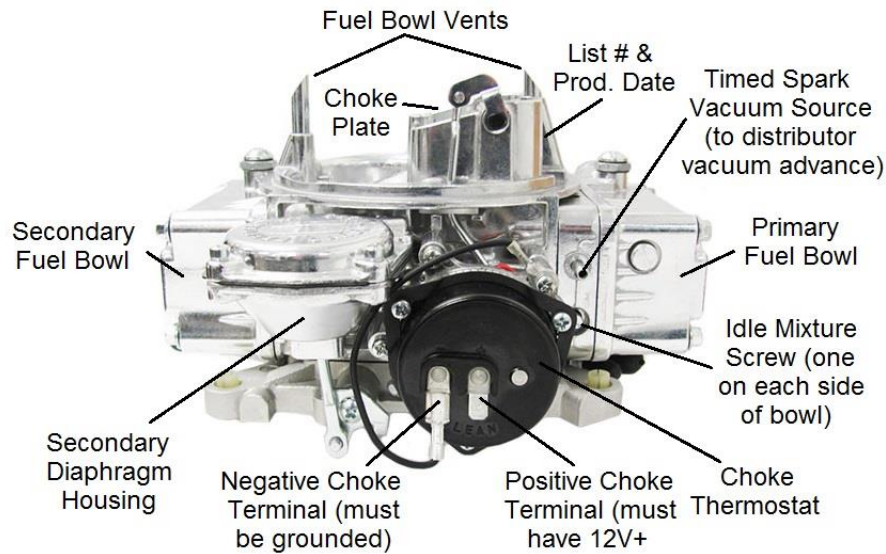

Figure 2a.

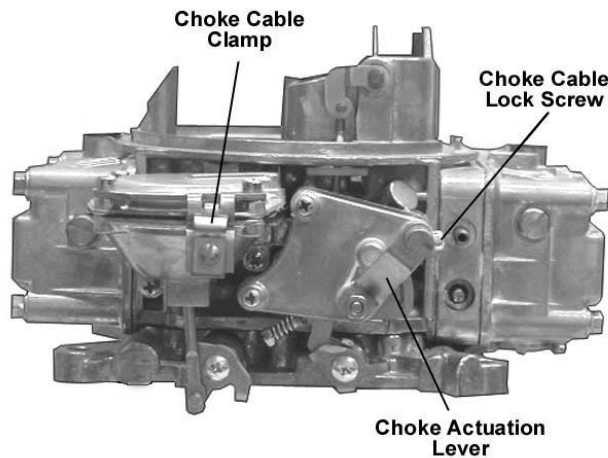

Figure 2b. Manual choke parts (0-1850 shown)

6. Reconnect the appropriate vacuum hoses to the carburetor, noting the correct fitting from **Figure 2a** and **Figure 3**. Replace any cracked or dry rotted hoses at this time to prevent any vacuum leaks.
 - A. The full manifold vacuum source in the front of the throttle body provides vacuum for proper operation of the air cleaner, the pump diverter valve (if equipped), AC/Cruise, and/or the temperature sensing valve. If vacuum for more than one component is needed, use small plastic vacuum "T"s (available at most automotive stores).
 - B. The timed spark fitting in the choke side of the primary metering block provides vacuum for the operation of the distributor vacuum advance. Connect the hose to the distributor, spark delay valve, and/or temperature sensing valve as originally connected. Again use "T"s as necessary. If any questions arise about the hose connections, consult the proper service manual.
 - C. Plug any vacuum source not used. **(The Choke Fresh Air Intake Hose is not drilled, so no plug is needed.)**
7. Connect the PCV hose to the PCV fitting in the carburetor base plate.
8. Connect the power brake and/or PCV hose to the fitting (**Figure 3**).

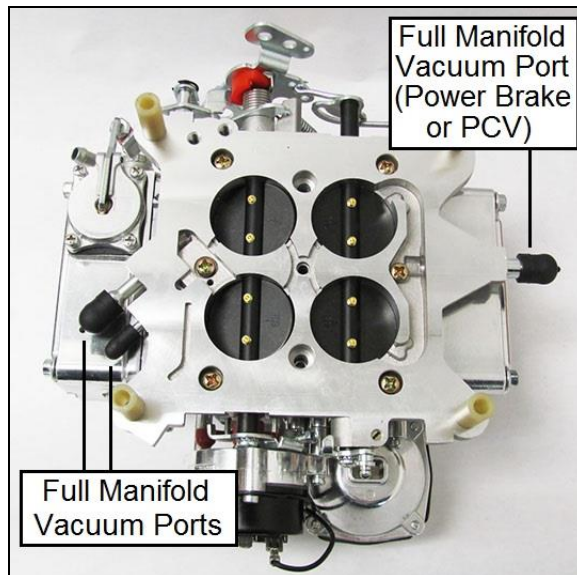

Figure 3

9. In some cases, the existing fuel line will have to be cut and connected to a “dual feed” fuel line with a length of rubber fuel hose and a clamp.

WARNING: During the fuel line installation, **DO NOT** allow any foreign particles to enter the fuel lines, which could then cause flooding and may result in a fire.

WARNING: Keep the fuel line away from the EGR valve (if equipped) on the intake manifold.

If installation requires cutting the metal fuel line, cut the fuel line with a good tube cutter. This will minimize the chance of producing metal chip particles. If a hacksaw must be used then metal chips must be removed.

WARNING: In all cases where the fuel line has been cut, it is essential that it be clean to insure that no metal particles enter the fuel bowl after the new carburetor installation. Remove the fuel line at the pump and blow the line clean with compressed air. **DO NOT** use the procedure where the coil wire is disconnected, the engine cranked for a few revolutions, and the fuel collected in a container. This procedure is unsafe because sparking can occur either at the coil or at the distributor end of the coil wire and ignite any fuel spilled in the engine compartment.

CAUTION: The use of a quality in line fuel filter, such as Holley® P/N 162-523 is mandatory as a safeguard against possible flooding, which could result from unfiltered particles becoming lodged between the fuel inlet needle and its seat. This can result in fire if a spark is present or backfire occurs in the engine compartment. Air cleaner filter elements should be blown clean with compressed air at 6,000 miles and replaced at 12,000 miles to assure maximum protection. Now would be the perfect time to upgrade to a Holley® Powershot air filter (Holley® P/N 120-146).

ELECTRIC CHOKE MODELS:

- A. Connect the electric choke lead (supplied) to the positive terminal of the choke cap. **The other end must be connected to a good ignition activated 12-volt source.** Hookup of this wire is **not** optional.

WARNING: Connecting the choke cap to the ignition or ignition coil could result in unacceptable choke operation, poor fuel economy, and possible engine misfiring, since the voltage delivered to the spark plugs will be severely reduced by the drain imposed by the choke cap. Suitable ignition activated 12-volt sources are most electrical relays, as well as the leads to accessories, such as windshield wipers. **DO NOT** connect this wire to the original equipment (O.E.) electric choke source. This may not be a 12V source.

- B. Check the voltage source with a volt-ohm meter to assure proper voltage and choke operation. Provision of a good ground and 12 volt+ source that can supply enough current to the choke cap is *essential* for proper choke operation!

MANUAL CHOKE MODELS:

- A. Connect the choke control cable (Holley® P/N 45-228) to the choke actuation lever, and lock in place with the choke cable lock screw.
- B. Mount the outer sleeve to the cable clamp.
- C. Actuate the choke cable through its full range of motion to ensure full choke operation. Adjust as necessary.

10. Start the engine and check the fuel lines and inlet fitting for possible leaks.

NOTE: The recommended fuel pressure is 5-7 psi. Use an adjustable fuel pressure regulator (Holley® P/N 12-803) if it is higher than 7 psi.

11. Recheck to assure all existing vacuum hoses are attached properly. Plug any fittings not used.

12. With the engine at operating temperature, set the idle speed to the manufacturer's specifications (see page 12 for idle adjustment).

13. Shut off the engine and readjust the throttle operated transmission linkage, if necessary. On installations that have a kickdown-actuating switch on the passenger's side of the firewall, it might be necessary to readjust it according to the manufacturer's service manual.

FORD APPLICATIONS WITH AUTOMATIC TRANSMISSIONS: With the engine off, push the transmission kickdown rod rearward until it stops and hold it in position. Push the throttle lever rearward to its wide-open throttle position and adjust the transmission kickdown screw to come in contact with the transmission kickdown lever tang.

WARNING: With the engine off, recheck the assembled linkage for sticking and/or proper return to the idle position.

14. Place the air cleaner gasket (supplied) on the sealing flange, and install the air cleaner.

15. With some air cleaner configurations, it may be necessary to use an air cleaner spacer to provide adequate clearance between the carburetor and the air cleaner. Holley® offers such a spacer (Holley® P/N 17-13). Depending on the overall height, obtain the proper length 1/4 x 20 stud and install in the carburetor airhorn. Close the hood slowly to ensure adequate clearance between the air cleaner stud and the hood.

WARNING: Inadequate clearance between the air cleaner and the throttle lever could result in throttle sticking and uncontrolled engine speed. Check the clearance between the throttle lever and air cleaner for proper operation. Check the clearance between the air cleaner and the hood before closing the hood completely.

MAINTENANCE WARNING: Fuel system components, including fuel lines and the carburetor, should be inspected periodically to assure no fuel leakage and to ensure the soundness of the hoses. Today's clean emissions engines provide higher temperatures in the engine compartment. These high temperatures promote faster aging of non-metallic materials.

Hoses that exhibit surface cracks, when bent to 180°, should be replaced. The presence of liquid fuel demands tightening of fittings, hose replacement, and retorquing of the fuel system component flange nuts. Periodically check the torque on the fuel bowl screws to 25-30 in./lbs. to assure proper fuel metering.

GENERAL: Some very important factors to optimize efficiency and performance include: Correct engine timing, correct spark plug gap and heat range, ignition components in good working order, and correct operation of exhaust heat valve.

WARNING: On automatic transmission vehicles only, install the transmission kickdown adjustment screw and black retaining clip, as correctly indicated. Failure to attend to this detail may result in a sticking wide-open throttle or dangerous uncontrolled engine speed.

INSTALLATION NOTES:

CHRYSLER APPLICATIONS:

WARNING: This carburetor is not designed for use with any Chrysler automatic overdrive transmission. SEVERE transmission damage may result from improper application use.

1. Unless you are replacing an existing Holley® carburetor (which already has a lever extension arm), you may need to purchase and install a throttle lever extension (Holley® P/N 20-7) on the carburetor. Remove the throttle stud and nut from the original carburetor. You can purchase a new stud from your Holley® dealer (Holley® P/N 20-67). Install the stud in the throttle extension lever (**Figure 4**).

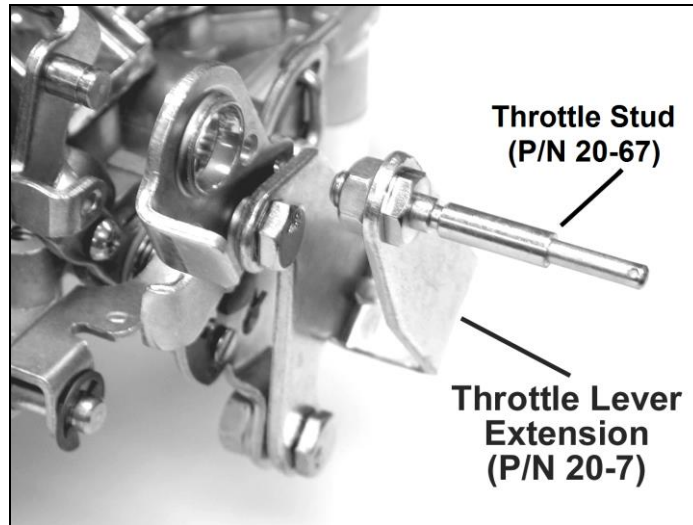

Figure 4—Chrysler applications

FORD APPLICATIONS:

WARNING: This carburetor is not designed for use with any Ford automatic overdrive transmission. SEVERE transmission damage may result from improper application use.

NOTE: Unless replacing an existing Holley® Carburetor, you may need to purchase Holley® P/N 20-93, spring and perch kit, for Ford automatic transmissions.

1. Unlock transmission kickdown lever by removing screw and spring and relocating to additional hole in the transmission kickdown lever (**Figure 5**).
2. Install snap ring on the transmission kickdown lever.
3. Install transmission kickdown lever return spring bracket using supplied screws and lockwashers.
4. Install transmission kickdown lever spring between the transmission kickdown lever and kickdown return spring bracket.

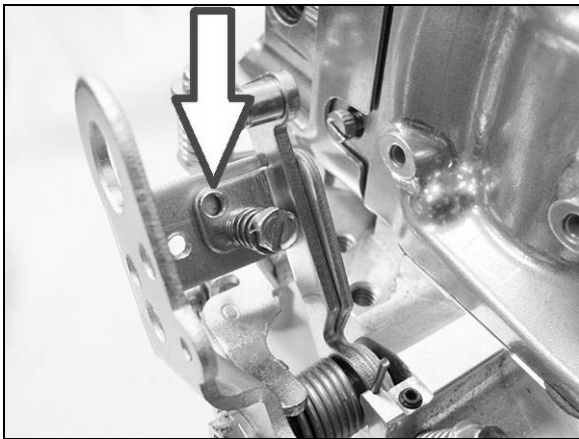

Figure 5

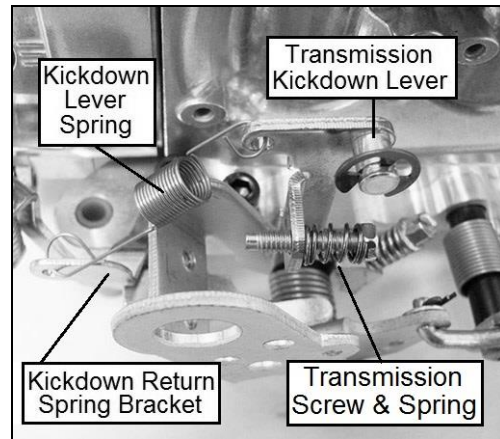

Figure 6

5. Install the transmission kickdown spring between the transmission kickdown lever and spring perch (**Figure 6**).

GM APPLICATIONS:

1. Remove the throttle cable ball and automatic transmission kickdown stud (if any) from the original carburetor, and mount these in similar locations on the Holley® throttle lever. If the original throttle cable is too large, a new throttle ball or stud is needed (Holley® P/N 20-2 or 20-38).

NOTE: For proper adjustment of the GM automatic kickdown linkage, refer to the appropriate GM service manual for your application.

WARNING: On automatic transmission vehicles only, install the transmission kickdown adjustment screw and black retaining clip, as correctly indicated. Failure to attend to this detail may result in a sticking wide-open throttle or dangerous uncontrolled engine speed.

Connecting the Transmission Linkage:

GM TH350, 200R4 /700R4

Attach the transmission kickdown stud (supplied) into the proper hole location on the throttle lever as seen in (Figure 7). Attach the TV cable to the stud and adjust per transmission manufacturer's specifications, using Chilton®, Motor®, or other repair manual designed for your specific transmission.

WARNING: If you are unfamiliar with overdrive transmission TV cable adjustments, consult a qualified transmission expert. Failure to properly adjust the TV cable on overdrive transmissions can lead to poor shifting and / or transmission failure. Holley Performance Products assumes no responsibility for transmission damage or failure caused by improperly adjusted TV cables.

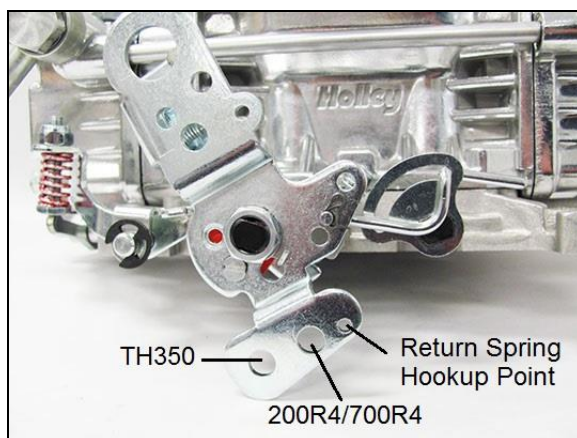

Figure 7

CHOKE ADJUSTMENT:

IMPORTANT: Your Holley® carburetor has been factory wet flowed and calibrated. The “out of the box” settings should be very close for all adjustments. The following tuning section is included ONLY to aid you in fine tuning adjustments.

Electric Choke

1. You can control the choke operation by rotating the choke cap. If the choke comes off too soon, loosen the three screws and rotate the cap counterclockwise one notch at a time, until the choke operation is satisfactory. If the choke comes off too late, rotate the cap clockwise one notch at a time, until the choke operation is satisfactory. The choke setting from the factory is on “index” or at center position. After making the final adjustments, start the engine and make sure the choke plate opens completely.
 - A. A choke that comes off too soon could exhibit one or more of the following symptoms: stalling, surging, backfiring, stumbles, or poor vehicle driveability when the vehicle is cold.
 - B. A choke that comes off too late could exhibit one or more of the following symptoms: black smoke from the tail pipe, poor driveability when cold, poor gas mileage, misses, or rough idle.

Manual and Electric Chokes

1. If the fast idle RPM is too low or too high for your preferences, SHUT DOWN THE ENGINE! Advance the throttle to wide-open, exposing the fast idle set screw below the choke housing (**Figure 8**).
2. Using a 1/4” open end wrench, turn the screw clockwise to increase the RPM or counterclockwise to decrease the RPM. The factory setting should give you a 1500-1600 RPM fast idle speed.

NOTE: All vacuum ports must be plugged at this time.

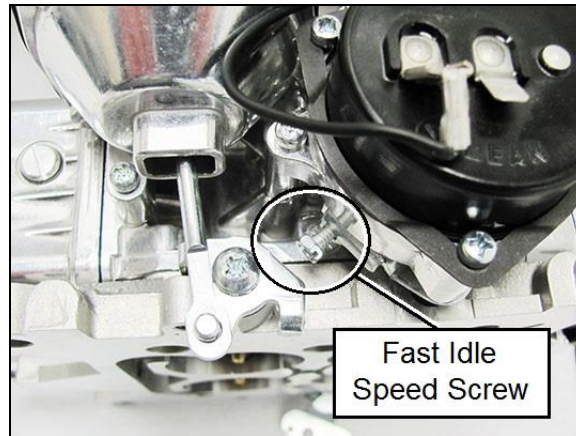

Figure 8

FUEL LEVEL:

(Float Level) – for Adjustable Needle & Seat Equipped Bowls: 0-80457S & 0-1850S:

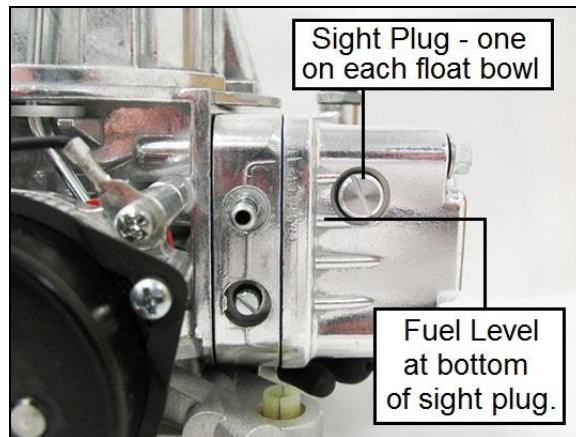

Figure 9

The float(s) controls the fuel delivery, however if the float(s) are not properly adjusted a fuel starvation or a flooding affect could result. This operation is difficult to do accurately on a rough-idling vehicle.

1. Mechanical fuel pump, remove coil wire and crank engine over for 10 seconds to allow fuel bowls to fill. This procedure can prevent a power valve blow out. Reconnect coil wire when finished. Electric fuel pumps, let the fuel bowls fill in stages by turning the ignition on and then off, let fuel pump run for a few seconds at a time. This procedure can prevent the needle from being forced up at an angle not allowing the needle to seat properly.
2. Remove the sight plug from the fuel bowl and start the vehicle.
3. Loosen the lock screw at the top of the assembly.
4. Turn the adjusting nut while holding the screw in place until the fuel level is at the bottom of the sight plug hole even with the threads. A slight trickle can be seen at the threads. Turn the adjusting nut clockwise to lower the fuel level and counter-clockwise to raise the fuel level.

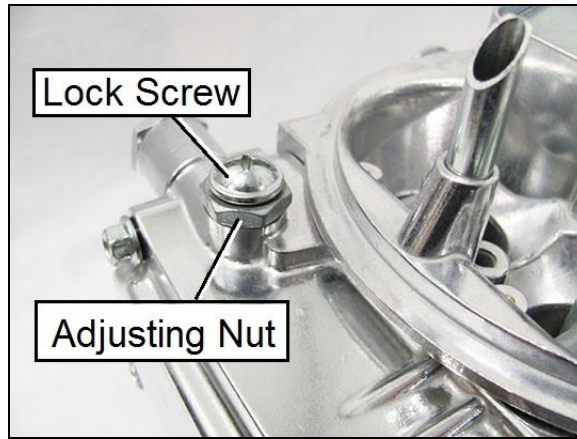

Figure 10

5. Tighten the lock screw while holding the adjustment nut.
6. Replace the sight plug and finger tighten.
7. Flush the fuel bowl by revving the engine a few times with the transmission in the neutral.
8. Remove the sight plug to confirm your setting. A slight trickle should be seen at the threads. Adjust, if necessary.
9. Replace the sight plug and tighten.

IDLE MIXTURE NEEDLES:

Idle mixture needles control the air/fuel mixture at idle. These have been preset at the factory and SHOULD NOT need any adjustments. However, if you feel that adjustment is necessary, you can use the following procedure to do so. When tuning the idle mixture, you're actually tuning for the best manifold vacuum. Idle mixture needles are found on the primary metering blocks. If you change one idle mixture needle, you must change the other idle mixture needle by the same amount. Here are the proper steps for setting the idle mixture needles.

1. Attach the vacuum gauge to a manifold vacuum port on the throttle body (**Figure 3**).
2. Adjust each idle mixture screw (**Figures 12 & 13**) 1/8 turn at a time, alternating between each screw. Turn them equally, until you achieve the highest possible vacuum reading without adjusting the curb idle speed screw. Turn screws in to lean the mixture. Turn them out to richen the mixture.

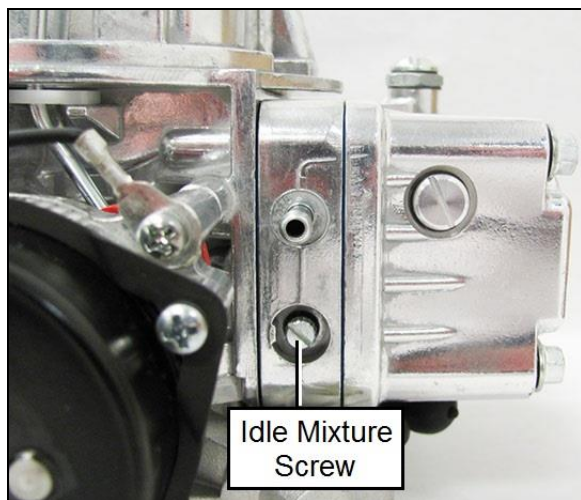

Figure 12

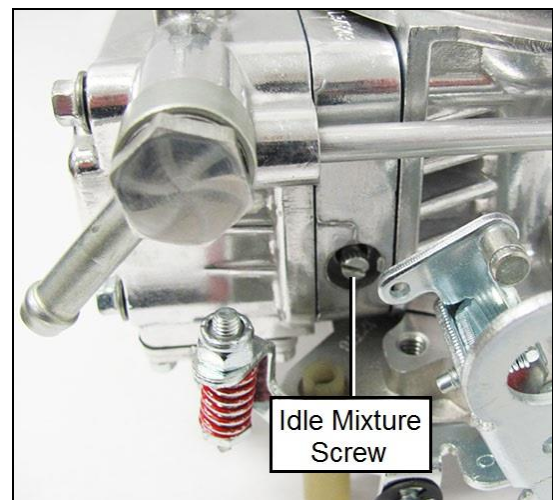

Figure 13

3. Now that the idle mixture is set, it may be necessary to go back and reset the idle speed using the curb idle speed screw, as shown in **Figure 14**.
4. If a vacuum gauge is not available, use a tachometer to obtain the highest RPM.

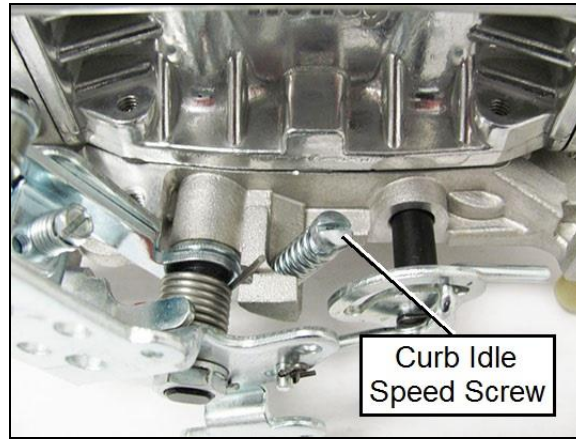

Figure 14

ROUGH IDLE AND VACUUM LEAKS: If a rough idle persists after the engine has been started and the mixture screws adjusted, check for manifold vacuum leaks. These could result from unplugged vacuum fittings or a carburetor flange gasket that was torn during installation. Recheck for proper attachment of all vacuum lines and check the lines for cracks. If the manifold was changed, a manifold vacuum leak could occur at the cylinder head/manifold surface due to damaged gaskets or improper torquing. Frequently, manifold vacuum leaks occur from the valley side of the manifold. These are very difficult to detect, unless a discernible whistle can be heard.

NOTE: In most cases, when rough idle occurs after a carburetor/manifold change, they result from manifold vacuum leaks similar to those described above. Assuring a proper manifold installation rather than assuming the carburetor is not functioning properly will ultimately save time.

VACUUM OPERATED SECONDARY THROTTLES:

Many people have the misconception that opening the secondary throttles sooner will provide increased performance and quicker drag strip times. Others think they must “feel” a kick when the secondaries engage. Still others believe that they should disconnect the vacuum diaphragm and make the secondaries open mechanically.

Before going any further, let’s discuss these points in a reverse order. First, if we could make our vacuum operated secondary carburetors perform better by opening the secondaries mechanically, it would be to our advantage to do so since all that vacuum actuating hardware is expensive and requires much time and money to calibrate. Mechanical secondary carburetors all utilize a secondary pump shot to prevent bogging when the secondaries are opened. Secondly, those who “feel” a kick when the secondaries engage are actually feeling a flat spot during initial acceleration, because the secondaries have already begun to open and have weakened the fuel delivery signal to the primary boosters. The engine is struggling to increase speed and what they actually feel are the secondary nozzles “crashing in” as the engine finally reaches the speed where it provides the proper fuel delivery signal to primary and secondary venturi. Third, opening the secondaries early causes the situation described above. The secondaries must not open until the engine requires the additional air. This allows torque to increase along the peak torque curve. Performance is compromised less by holding the secondaries closed a little longer than by opening them a little too soon. If the opening rate of the vacuum operated secondaries is properly calibrated there should not be a “kick”, only a smooth increase in power should be felt.

In general, heavier cars require stiffer secondary diaphragm springs than light cars. Air cleaner configuration and restriction plays an important part in spring selection also, so be sure to use your air cleaner when evaluating your vehicles performance after each change. **DO NOT** expect to “wing” the throttle and see the secondaries begin to open. If they do they will probably open too soon. Secondaries should open only when the engine is under a load. **DO NOT** clip or trim a spring in an effort to make a spring lighter so that the secondaries will open sooner. Strange as it may seem, clipping springs actually increases spring rate and will delay opening. So in order to tune the secondaries follow the steps below. A secondary spring kit is available from your local Holley® retailer (Holley® P/N 20-13).

VACUUM OPERATED SECONDARY TUNING:

NOTE: The Holley® Quick Change Diaphragm Housing Cover makes swapping secondary springs a matter of loosening two screws. It is available under P/N 20-59.

1. Remove the choke cap (electric choke) and choke housing (manual and electric choke) to gain access to the third screw retaining the vacuum diaphragm to the main body (**Figure 15**).
2. Remove three screws attaching secondary vacuum diaphragm to the main body (**Figure 16**).

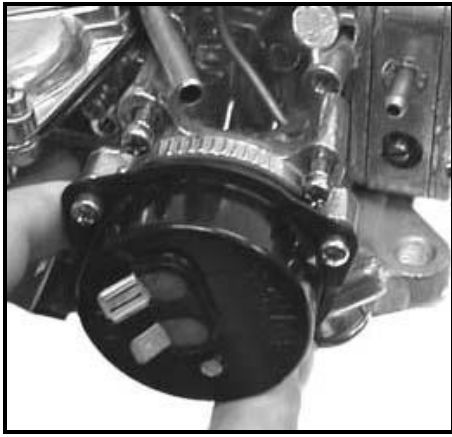

Figure 15

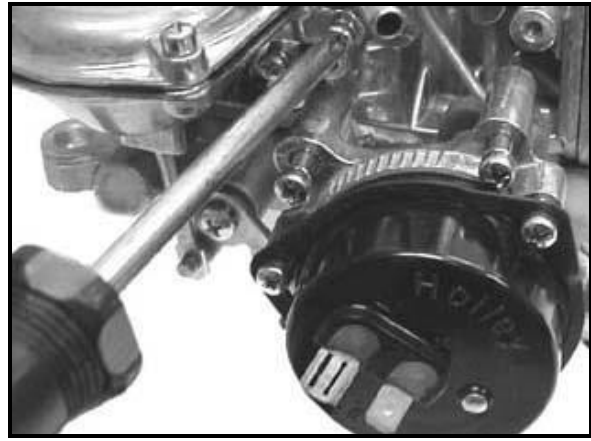

Figure 16

- Remove the clip retaining the diaphragm plunger to the secondary throttle lever using a small flat-blade screwdriver (Figure 17).

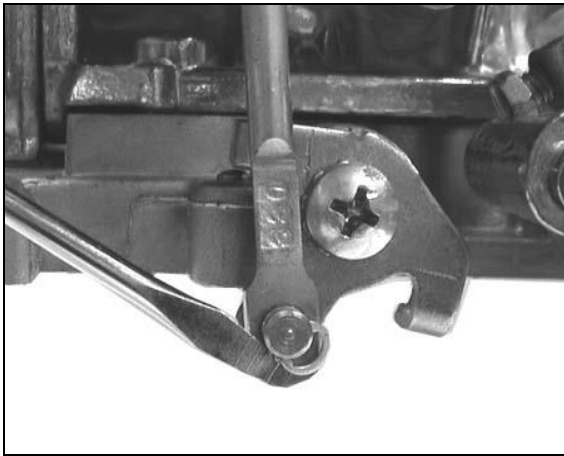

Figure 17

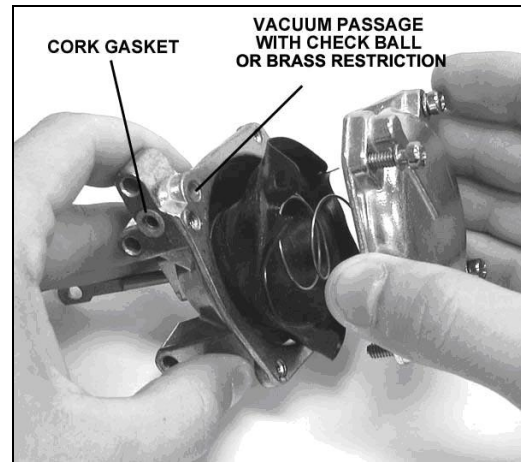

Figure 18

- Remove the four screws securing diaphragm cover.
 - Gently remove the cover. Take care as not to tear the diaphragm or loose the check ball (Figure 18). **NOTE: Your secondary housing may have a brass restriction inserted where the check ball should be. If that is the case, please disregard all references to the check ball as yours does not use a check ball.**
 - Change the spring. Make sure that the new spring seats on the stud cast into the underside of the cover. The stiffer the spring, the later the secondaries will open.
 - When reassembling secondary diaphragm parts, exercise care to properly align the vacuum passage in the casting with the “cut out” in the rubber diaphragm, and make sure the check ball is in place. **DO NOT** pinch or tear the rubber diaphragm.
- TIP:** To make reassembling the diaphragm easier, push the diaphragm arm into the housing and form the diaphragm into a “mushroom” shape (Figure 19). Then position the diaphragm over the bolt holes and vacuum port. Hold the diaphragm in that position with your fingers while inserting the spring, cover, and bolts to avoid disturbing the position of the diaphragm.
- Make sure the cork gasket in the secondary diaphragm housing mates with the main body casting and reassemble the housing and choke to the main body.
 - Reinstall the air cleaner, and test drive the vehicle.

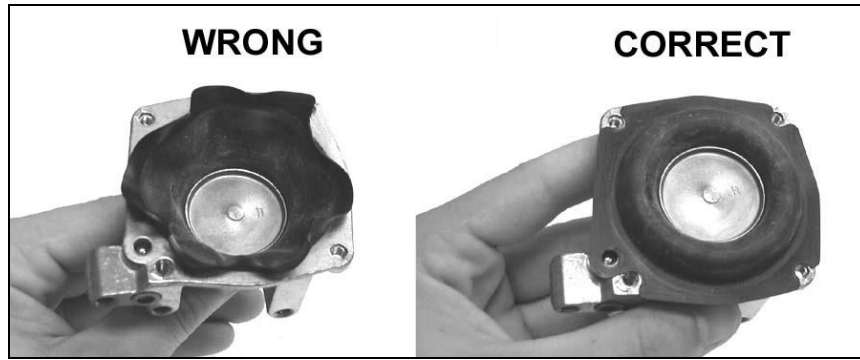

Figure 19

JETTING (MAIN JETS):

Due to varied applications that a universal performance carburetor will work with, a few tips on jetting are provided to help you understand their purpose.

1. Out of the box jetting is extremely close for most applications.
2. Carburetors are calibrated at 70° at sea level. Decrease the jet size primary and secondary, one number for every 2000 ft. increase in altitude.
3. Holley® jets are broached, flowed, and stamped according to flow rate. **NEVER** drill jets, as this seriously alters flow characteristics. Stamped numbers are reference numbers and **DO NOT** indicate drill size.
4. In most cases it will be **unnecessary** to increase jet size more than four numbers greater than out of the box jetting. Exceptions could arise when the carburetor is mounted on a very large volume, plenum-ram manifold.
5. Spark plugs provide the best indication of proper jetting. Consult an ignition manual for proper reading of spark plugs.

POWER VALVES:

The number stamped on a power valve, such as 65, indicates the manifold vacuum below which the power valve is operational. In this case, all manifold vacuums below 6.5" Hg, the power valve is operating. Generally a 65 power valve is sufficient for most high performance applications that have a manifold vacuum of 12" Hg or higher. However, some problems can result with radically cammed machines equipped with automatic transmissions. These vehicles often "idle" at 2000 rpm, approx. 6.0" Hg. At this point the main nozzles are starting to feed and richen the mixture (supplied by the power valve) and the engine will probably "load up". To correct this problem, install a 45 or 35 power valve. If the engine has a manifold vacuum of 12" Hg or less, a good way to determine power valve size is take the manifold vacuum at idle and divide that number by two. The answer is the power valve size. This will provide idling and proper fuel flow under wide open throttle conditions when manifold vacuums seldom rise above 1" Hg.

CARBURETOR SPECIFICATIONS:

CARBURETOR #	PRIMARY METERING JET	SECONDARY METERING PLATE	PUMP DISCHARGE NOZZLE	PRIMARY POWER VALVE	SECONDARY DIAPHRAGM SPRING
0-80457S	66	34R9716-6	0.031	65	Plain
0-1850S	66	34R9716-6	0.031	65	Plain



HOLLEY STREET WARRIOR™ WARRANTY

All Holley Performance Products Limited Warranties are extended to the original consumer only. This Limited Warranty is not assignable or otherwise transferable. There are no warranties that extend beyond those stated herein. Holley Performance Products offers no other warranties expressed or implied beyond this Limited Warranty.

In the event of an alleged defect in material or workmanship, Holley Performance Products' responsibility is strictly limited to repair or replace the defective product. Holley has no other obligation expressed or implied. Final warranty determination will be in the sole discretion of Holley Performance Products. Holley shall not be responsible for; (a) actual or alleged labor, transportation, or other incidental charges; or (b) actual or alleged consequential or other damages incurred by use of any product of Holley Performance Products.

To initiate the warranty process, the consumer must return the alleged defective product to the place of purchase with a dated receipt and completed applicable warranty claim tag. Warranty claims will be rejected if the date of purchase cannot be established by the consumer. Do not send products directly to Holley Performance Products. Holley Performance Products assumes no responsibility for products sent directly to Holley Performance Products.

This Limited Warranty sets forth specific legal rights. The consumer may have other rights as a result of variations in state laws or provincial laws. This Limited Warranty supersedes all prior warranty statements.

HOLLEY – NEW PRODUCT

Holley Performance Products warrants its new Holley products to be free from defects in material and workmanship for a period of 1 year from date of purchase.

Holley Performance Products Limited Warranty specifically does not apply to products, which have been (a) modified or altered in any way; (b) subjected to adverse conditions, such as misuse, neglect, accident, improper installation or adjustment, dirt or other contaminants, water, corrosion, or faulty repair; or (c) used in other than those applications recommended by Holley Performance Products. Holley Performance Products also does not warrant, and disclaims all liability for products used in racing activities and/or applications other than those specifically recommended in the current brand catalog.

Holley Performance Products, Inc.
Technical Service: 1-866-464-6553 or www.holley.com

© 2016 Holley Performance Products, Inc. All rights reserved. Tous Droits Réservés.

199R11081

Revision Date: 4-9-19